



LEO2

Compact digital manometer with high accuracy

Features

- High accuracy 0,1 %FS
- Compact design
- Insulated piezoresistive pressure sensor encapsulated in an oil-filled metal housing
- Energy-efficient: battery life of up to 1000 operating hours
- Optional: Intrinsically safe version LEO2-Ei available for use in potentially explosive atmospheres

Functions

- Wide range of units of pressure to choose from
- Zero point calibration via buttons
- Automatic shutdown
- Min / max display

Typical applications

- Industrial applications
- Servicing
- Calibration / testing



Accuracy

± 0,1 %FS

Total Error Band

± 0,2 %FS

Pressure Ranges

0...4 bar to 0...700 bar



LEO2

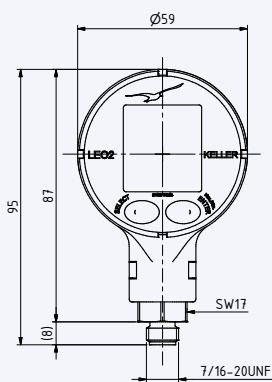

LEO2 with rubber cover

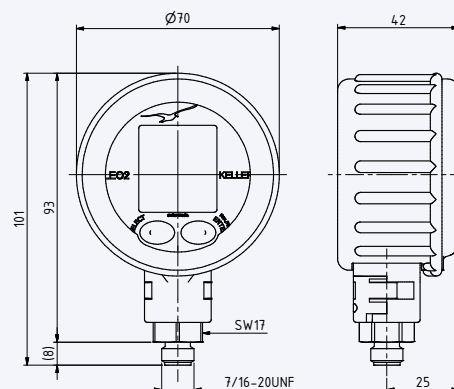



LEO2 – Specifications

Standard pressure ranges

Absolute pressure, PAA	0...4	0...11	0...31	0...101			bar abs.
Absolute pressure, PA					0...300	0...700	bar
Overload resistance	10	20	60	200	400	700	bar
Display resolution (LCD)	0,001	0,002	0,01	0,02	0,1	0,2	bar

Key	PAA	Sealed	Zero at 0 bar abs. (vacuum)
	PA	Sealed	Zero at 1 bar abs.

Performance

Pressure

Accuracy @ RT (20...25 °C)	$\leq \pm 0,1$ %FS	Nonlinearity (BFSL), pressure hysteresis, non-repeatability, zero point deviation and amplification deviation
Total error band (0...50 °C)	$\leq \pm 0,2$ %FS	Max. deviation within the specified pressure and temperature range
Long-term stability	$\leq \pm 0,2$ %FS	Per year under reference conditions, yearly recalibration recommended
Degree of dependency on location	$\leq \pm 1,5$ mbar	Calibrated in vertical installation position with pressure connection facing downwards
Pressure range reserve	$\geq \pm 10$ %	Valid measured values outside the pressure range, no overflow/underflow

Temperature ranges

Compensated temperature range	0...50 °C
Media temperature range	-10...60 °C
Ambient temperature range	0...50 °C
Storage temperature range	-20...70 °C

Electrical data

Battery	3 V, type CR2430	Only CR2430 from Renata permitted for hazardous applications (LEO2-Ei)
Battery life	Up to 1000 hours	When used continuously
CE conformity as per 2014/30/EU (EMC)	EN 61000-6-1 to -6-4 EN 61326-1 / EN 61326-2-3	



LEO2 – Specifications

Display

Dimensions	Width x height: 27.8 mm x 30.0 mm (see Dimensions and options)
Number of digits on LC display	2 rows with 4 1/2 digits each
Measuring rate	2 measurements per second
Configurable units of pressure	bar, mbar, hPa, kPa, MPa, PSI, kp/cm ²

Mechanical data

Materials in contact with media

Pressure connection	Stainless steel AISI 316L
Pressure transducer separating diaphragm	Stainless steel AISI 316L
Pressure transducer seal (internal)	None
Swivel insert	Nickel-plated brass
Swivel O-ring	NBR
Adapter	Galvanised steel
Adapter seal (external)	NBR

Other materials

Display housing	Polyamide
Pressure transducer oil filling	Silicone oil

Further details

Pressure connection	7/16 - 20 UNF with G1/4 adapter	See Dimensions and options for other optional adapters
Diameter x height x depth	59 mm x 95 mm x 32 mm	Without rubber cover
	70 mm x 101 mm x 42 mm	With rubber cover
Weight	approx. 125 g	Without rubber cover and adapter
Protection	IP65	

Explosion protection LEO2-Ei

Intrinsically safe version LEO2-Ei in accordance with 2014/34/EU (ATEX) and IECEx	LCIE 01 ATEX 6001 X IECEx LCIE 18.0035 X Zone 0: Ex II 1G Ex ia IIC T5 Ga	Permitted max. ambient temperature range -10...80 °C
---	---	--



LEO2 – Dimensions and options

LC display

Front cover	Content	Dimensions
		Width x height: 27,8 mm x 30,0 mm Digit height: top: 8 mm x 3 mm bottom: 7 mm x 3 mm

Available pressure connections

A swivel adapter with a G1/4 connection on the process side is supplied as standard with every LEO2. The swivel adapter is a cylinder with O-rings on each side. This allows the device to be optimally positioned. The following adapters are also available:

Principle Swivel adapter	G1/4 swivel adapter (standard)	G1/8 swivel adapter	1/4-18NPT swivel adapter	G1/4 EN 83 adapter, without swivel, alignment not possible

The process of fitting the adapter with the swivel seal insert is described in the operating instructions.





Other customer-specific options

- Customer-specific front covers
- Customer-specific firmware with e.g. application-specific calculations
- Other oil filling types for pressure transducers: e.g. special oils for oxygen applications
- Other units of pressures can be configured ex works







LEO2 – Scope of delivery and accessories

Scope of delivery

Plastic case	Renata CR2430 battery	G1/4 swivel adapter	Operating instructions D/E/F
			

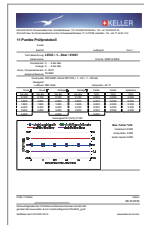
Accessories

Rubber cover	KELLER 5-point report	KELLER 11-point report	Carry case
			
For additional protection in harsh environments	Measurement deviation at room temperature	Measurement deviation at room temperature with hysteresis	With belt loop

Order information

Standard versions		Intrinsically safe versions	
Technical description	Product number	Technical description	Product number
LEO2 / 4 bar	303010.0002	LEO2-Ei / 4 bar	303010.0006
LEO2 / 11 bar	303010.0015	LEO2-Ei / 11 bar	303010.1906
LEO2 / 31 bar	303010.0005	LEO2-Ei / 31 bar	303010.0007
LEO2 / 101 bar	303010.0072	LEO2-Ei / 101 bar	303010.1910
LEO2 / 300 bar	303010.0004	LEO2-Ei / 300 bar	303010.0003
LEO2 / 700 bar	303010.0001	LEO2-Ei / 700 bar	303010.0008

www.guemisa.com



NIF: B-87969416

SENSORES E INSTRUMENTACION GUEMISA S.L.
 C\ La Fundación 4 Bis - Pl 1ª Oficina-2
 28522 Rivas Vaciamadrid (Madrid)
 Telf. 91 764 21 00 email: ventas@guemisa.com